

Congratulations,

By purchasing the *Aurelia* you have made an excellent choice.

The purchase of a professional espresso coffee-maker involves various elements of selection: the name of the manufacturing firm, the machine's specific functions, its technical reliability, the option of immediate and suitable servicing, its price. You certainly evaluated all these factors and then made your choice: the *Aurelia* model.

We think you have made the best choice and after every coffee and cappuccino you will be able to assess this.

You will see how practical, convenient and efficient working with *Aurelia* is.

If this is the first time you have bought a **Nuova Simonelli** coffee machine, welcome to high quality coffee-making; if you are already a customer of ours, we feel flattered by the trust you have shown us..

Thanks of the preference.

With best wishes,

Nuova Simonelli s.r.l.

ENGLISH



Aurelia
MADE IN ITALY

TECHNICAL CHARACTERISTICS

ENGLISH

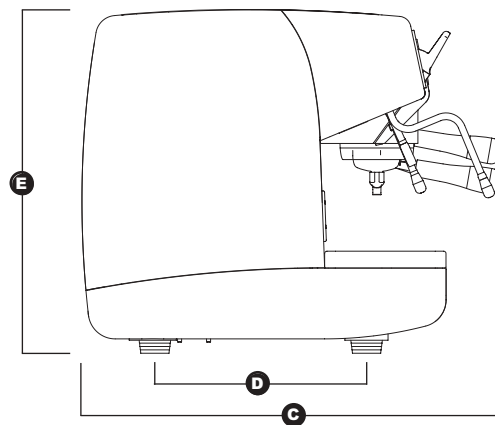
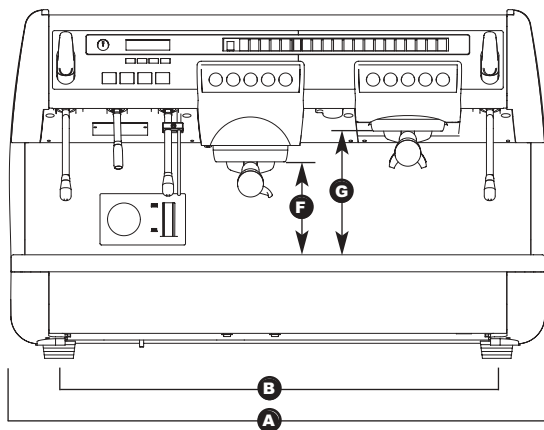

	2 Groups		3 Groups		4 Groups	
NET WEIGHT	74 kg	136 lb	88kg	194 lb	104 kg	229 lb
GROS WEIGHT	80kg	176 lb	98 kg	216 lb	120 kg	264 lb
POWER	4500 W	4500 W	5000 W	5000 W	5000 W	5000 W
DIMENSIONS	A 780 mm	A 30 1/4"	A 1010 mm	A 39 5/16"	A 1240 mm	A 48 5/16"
	B 635 mm	B 25"	B 865 mm	B 34"	B 1095 mm	B 43 1/16"
	C 540 mm	C 21 1/8"	C 540 mm	C 21 1/8"	C 540 mm	C 21 1/8"
	D 315 mm	D 12 3/16"	D 315 mm	D 12 3/16"	D 315 mm	D 12 3/16"
	E 510 mm	E 20"	E 510 mm	E 20"	E 510 mm	E 20"
	F 135 mm	F 5 1/8"	F 135 mm	F 5 1/8"	F 135 mm	F 5 1/8"
	G 180 mm	G 7 1/16"	G 180 mm	G 7 1/16"	G 180 mm	G 7 1/16"

Aurelia
MADE IN ITALY

INDEX

TECHNICAL CHARACTERISTICS34	
1. DESCRIPTION37	
1.1 ACCESSORIES LIST38	
2. SAFETY PRESCRIPTION39	
3. TRANSPORT AND HANDLING42	
3.1 MACHINE IDENTIFICATION42	
3.2 TRANSPORT42	
3.3 HANDLING42	
4. INSTALLATION AND PRELIMINARY OPERATIONS43	
5. ADJUSTMENTS TO BE MADE BY A QUALIFIED TECHNICIAN ONLY44	
5.1 FILLING BOILER MANUALLY44	
5.2 PRESSOSTAT/PUMP ADJUSTMENT44	
5.3 HOT WATER ECONOMISER ADJUSTMENT45	
5.4 CLOCK BATTERY REPLACEMENT (ONLY FOR THE VIP PLUS VERSION)45	
5.5 PUSH-BUTTON PANEL REPLACEMENT45	
5.6 ELECTRONIC DISPLAYS45	
6. USE46	
6.1 TURNING THE MACHINE ON46	
6.1.1 AURELIA VIP PLUS46	
6.1.2 AURELIA V/ESSE47	
6.1.3 AURELIA VIP-V/ESSE WITH ELECTRONIC DISPLAYS (OPTIONAL)47	
6.2 SELECTION CONFIGURATION48	
6.3 MAKING COFFEE48	
6.4 USING STEAM48	
6.5 MAKING CAPPUCCINO49	
6.6 HOT WATER SELECTION49	
6.7 TIMED STEAM NOZZLE49	
7. PROGRAMMING50	
7.1 KEY50	

7.2 PROGRAMMING AURELIA VIP PLUS50	
7.3 PROGRAMMING AURELIA V55	
7.4 PROGRAMMING AURELIA ESSE57	
8. CLEANING AND MAINTENANCE58	
8.1 SWITCHING OFF THE MACHINE58	
8.2 CLEANING THE OUTSIDE OF THE MACHINE58	
8.3 CLEANING STAINLESS COFFEE-HOLDERS58	
8.4 CLEANING THE UNIT WITH THE AID OF THE BLIND FILTER58	
8.5 CLEANING FILTERS AND FILTER-HOLDERS58	
8.6 RESIN AND SOFTENER REGENERATION59	
9. AURELIA PLUS MACHINE FUNCTION MESSAGES60	
10. AURELIA V MACHINE FUNCTION MESSAGES62	
11. AURELIA S MACHINE FUNCTION MESSAGES63	
ELECTRIC SYSTEM AURELIA S64	
ELECTRIC SYSTEM AURELIA PLUS Rel 3.xx65	
ELECTRIC SYSTEM AURELIA PLUS Rel 1.xx65	
ELECTRIC SYSTEM AURELIA V67	
PLUMBING SYSTEM68	

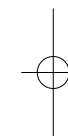
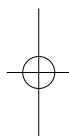

ENGLISH

Aurelia[®]
MADE IN ITALY

1. DESCRIPTION *Assolva* Vip Plus - V - Esse

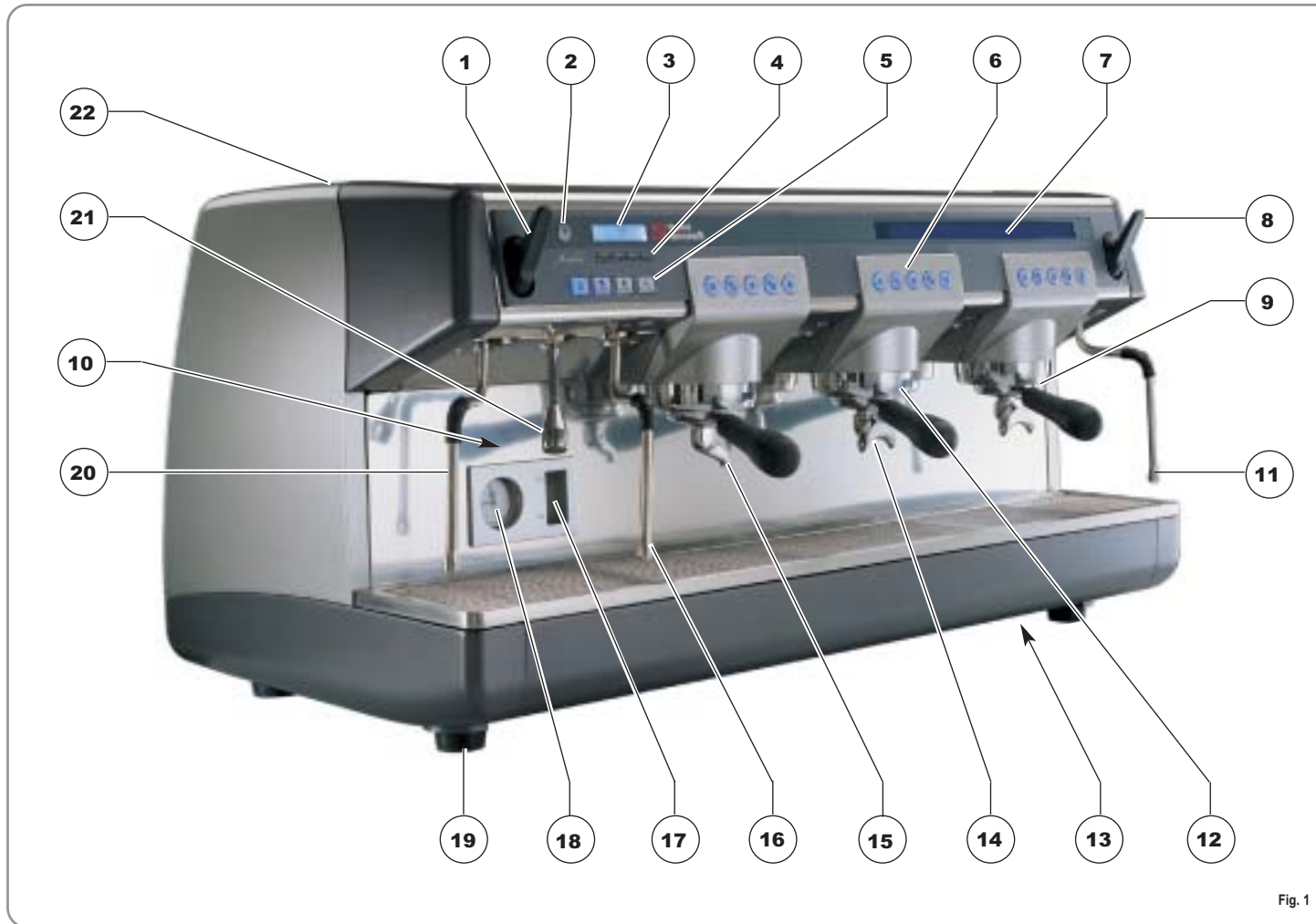

Fig. 1

ENGLISH

KEY

- 1 Steam knob
- 2 Programming key (Vip Plus only)
- 3 LCD Display (Vip Plus only)
- 4 Functions buttons (Vip Plus only)
- 5 Selections buttons
- 6 Delivery unit buttons
- 7 Electronic displays
- 8 Steam knob

- 9 Filter-holder
- 10 Data plate
- 11 Manual steam nozzle
- 12 Delivery unit
- 13 Main switch
- 14 2 coffees spout
- 15 1 coffee spout
- 16 Automatic steam nozzle (optional in V and

- ESSE version)
- 17 Optical level
- 18 Pressure Gauge
- 19 Adjustable foot
- 20 Manual steam nozzle
- 21 Hot water nozzle
- 22 Electric cup-warmer (steam cup-warmer, optional)

1.1 ACCESSORIES LIST

ENGLISH

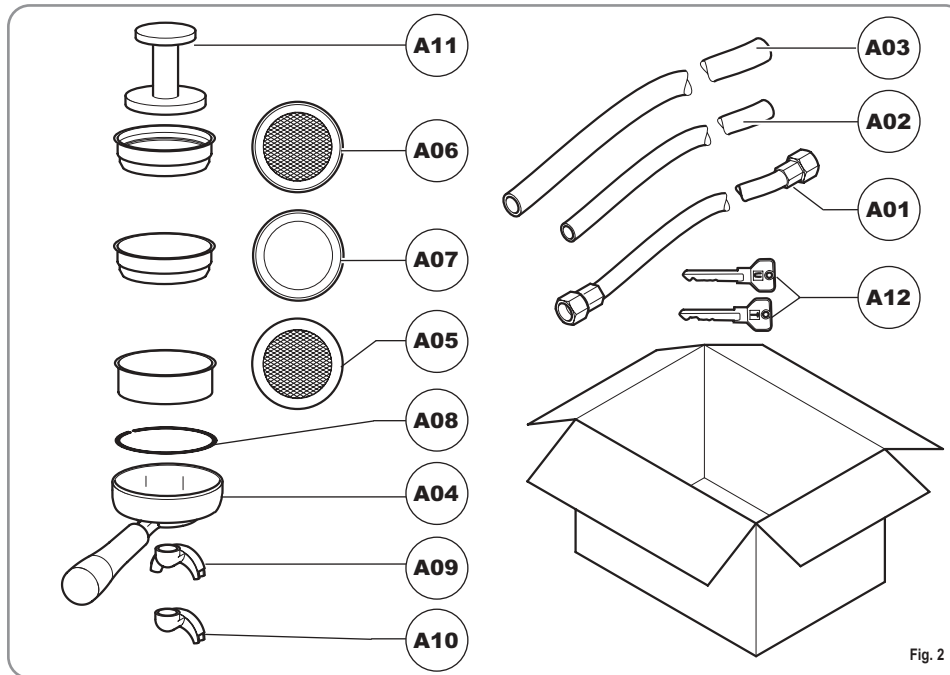

CODE	DESCRIPTION	2 GROUPS	3 GROUPS	4 GROUPS
A01	Filling tube 3/8"	1	1	1
A02	Unit tub draining tube Ø 20 mm - l. 150 cm	1	1	1
A03	Worktop draining tube Ø 25 mm - l. 150 cm	1	1	1
A04	Filter-holder	3	4	5
A05	Double filter	2	3	4
A06	Single filter	1	1	1
A07	Blind filter	1	1	1
A08	Spring	3	4	5
A09	Double delivery spout	2	3	4
A10	Single delivery spout	1	1	1
A11	Coffee presser	1	1	1
A12	'U' and 'T' keys (Plus model only)	1	1	1

2. SAFETY PRESCRIPTION

☞ This book is an integral and essential part of the product and must be given to the user. Read this book carefully. It provides important information concerning safety of installation, use and maintenance. Save it carefully for future reference.

☞ After unpacking, make sure the appliance is complete. In case of doubts, do not use the appliance, but consult a qualified technician. Packaging items which are potentially dangerous (plastic bags, polystyrene foam, nails, etc.) must be kept out of children's reach and must not be disposed of in the environment.

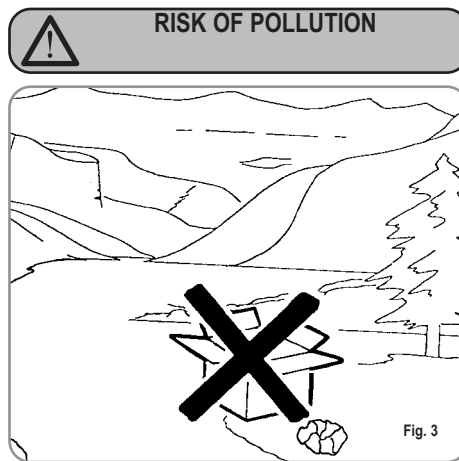

☞ Before connecting the appliance make sure the rating plate data correspond with the mains. This plate is on the front panel at the top right hand side of the appliance. The appliance must be installed by qualified technicians in accordance with current standards and manufacturer's instructions.

The manufacturer is not liable for any damage caused due to failure to ground the system. For the electrical safety of the appliance, it is necessary to equip the system with the proper grounding. This must be carried out by a qualified electrician who must ensure that the electric power of the system is sufficient to absorb the maximum power input stated on the plate.



☞ In particular you must ensure that the size of the wiring cables is sufficient to absorb power input.

The use of adapters, multiple sockets or extensions is strictly forbidden. If they prove necessary, call a fully qualified electrician.

☞ The machine must be installed according to the local standards in force with regard to plumbing systems. For this reason, the plumbing connections must be carried out by a qualified technician.

☞ This appliance must only be used as described in this handbook. The manufacturer shall not be liable for any damage caused due to improper, incorrect and unreasonable use.

Basic rules must be observed when using any electric appliance.

In particular:

- do not touch the appliance when hands or feet are wet;

CAUTION
RISK OF ELECTRIC SHOCK

- do not use the appliance when barefoot;
- do not use extensions in bath or shower rooms;
- do not pull the supply cord out of the socket to disconnect it from the mains;

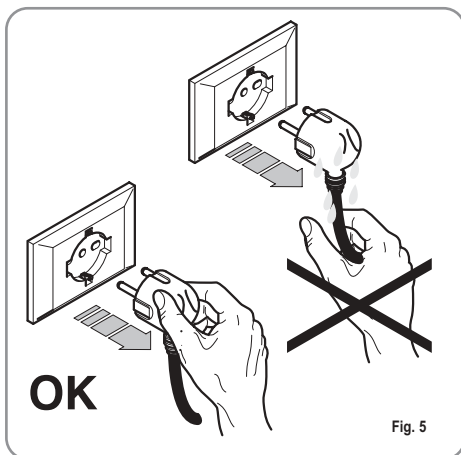

- do not leave the appliance exposed to atmospheric agents (rain, sun, etc.);
- do not let the appliance be used by children, unauthorised staff or staff who have not read and fully understood the contents of this handbook.

Before servicing the appliance, the authorised technician must first switch off the appliance and remove the plug.

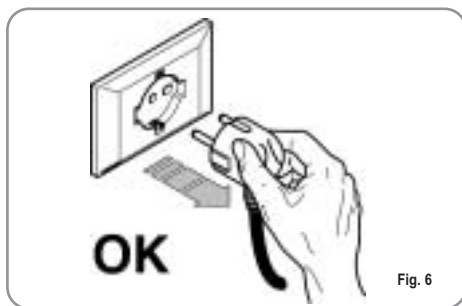

For all cleaning operations comply exclusively with the instructions given in this booklet.



If the appliance breaks down or fails to work properly, switch it off. Any intervention is strictly forbidden. Contact qualified experts only. Repairs should only be made by the manufacturer or authorized service centres. Only original spare parts must be used. Failure to observe the above, could make the appliance unsafe.

For installation, the qualified electrician must fit an omnipolar switch in accordance with the safety regulations in force and with 3 (0,12) or more mm (in) between contacts.

To avoid dangerous overheating, make sure the supply cord is fully uncoiled.

Do not obstruct the extraction and/or dissipator grids, especially of the cup warmer.

The user must not replace the appliance supply cord. If the cord is damaged, switch off the appliance and have a qualified technician change the cord.

If no longer using the appliance, we recommend making it inoperative; after removing the plug from the mains electricity, cut the power supply cable.

CAUTION
RISK OF POLLUTION

Do not dispose of the machine in the environment: to dispose of the machine, use an authorised centre, or contact the manufacturer for relative information.

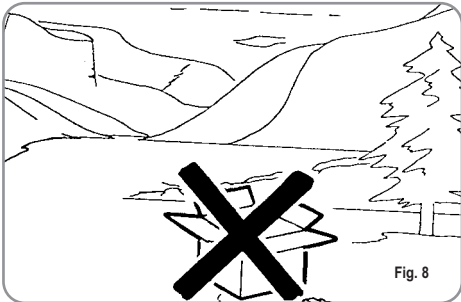

CAUTION
RISK OF INTOXICATION

Use the steam nozzle with care and never place hands below the jet of steam. Do not touch the nozzle immediately after use.



CAUTION
RISK OF BURNS OR SCALDING

We remind you that before carrying out any installation, maintenance, unloading or adjustment operations, the qualified operator must put on work gloves and protective footwear.

ENGLISH

3. TRANSPORT AND HANDLING

3.1 MACHINE IDENTIFICATION

Always quote the machine serial number in all communications to the manufacturer, Nuova Simonelli.



3.2 TRANSPORT

The machine is transported on pallets which also contain other machines - all boxed and secured to the pallet with supports.

Prior to carrying out any transport or handling operation, the operator must:

- put on work gloves and protective footwear, as well as a set of overalls which must be elasticated at the wrists and ankles. The pallet must be transported using a suitable means for lifting (e.g., forklift).

3.3 HANDLING

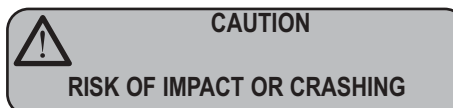

During all handling operations, the operator must ensure that there are no persons, objects or property in the handling area.

The pallet must be slowly raised to a height of 30 cm (11,8 in) and moved to the loading area. After first ensuring that there are no persons, objects or property, loading operations can be carried out.

Upon arrival at the destination and after ensuring that there are no persons, objects or property in the unloading area, the proper lifting equipment (e.g. forklift) should be used to lower the pallet to the ground and then to move it (at approx. 30 cm (11,8 in) from ground level), to the storage area.

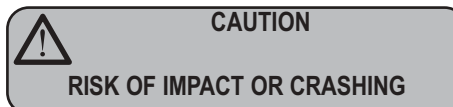

Before carrying out the following operation, the load must be checked to ensure that it is in the correct position and that, when the supports are cut, it will not fall.

The operator, who must first put on work gloves and protective footwear, will proceed to cut the supports and to storing the product. To carry out this operation, the technical characteristics of the product must be consulted in order to know the weight of the machine and to store it accordingly.

4. INSTALLATION AND PRELIMINARY OPERATIONS

After unpacking, assess that the machine and its accessories unit are complete, then proceed as follows:

- place the machine so that it is level on a flat surface;
- assemble its supporting feet by inserting the insert into the cylindrical unit;
- twist the rubber foot into the screw thread inside the unit;
- screw the whole assembled unit into the allotted setting for the machine's adjustable feet;
- level the machine by regulating the adjustable feet;

NOTE: the unit grooves have to face upwards, as shown in the following illustration.

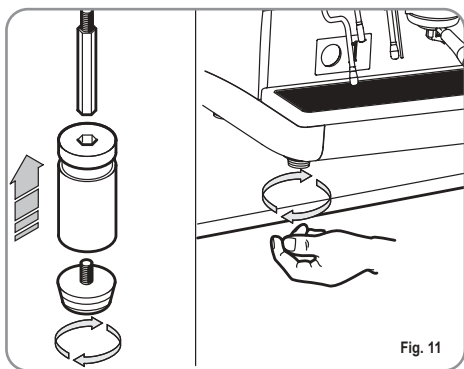

It is advisable to install a softener (1) and then a mesh filter (2) on the external part of the plumbing system, during preliminaries and after levelling the machine.

In this way impurities like sand, particles of calcium, rust etc will not damage the delicate graphite surfaces and durability will be guaranteed.

Following these operations, connect the plumbing systems as illustrated in the following figure.



WARNING

Avoid throttling in the connecting tubes. Assess that the drain pipe (3) is able to eliminate waste.

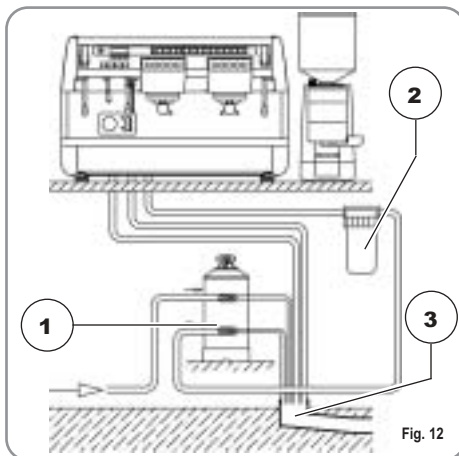

KEY

- 1 Softener
- 2 Mesh filter
- 3 Drain Ø 50 mm

NOTE: For a correct functioning of the machine the water works pressure must not exceed 4 bars.

Otherwise install a pressure reducer upstream of the softener; the internal diameter of water entrance tube must not be less than 6mm (3/8")



CAUTION RISK OF SHORT CIRCUITS

The machine must always be protected by an automatic omnipolar switch of suitable

power with contact openings of equal distance or more than 3mm.

Nuova Simonelli is not liable for any damage to people or objects due to not observing current security measures.

Prior to connecting the machine to the electrical mains, assess that the voltage shown on the machine's data plate corresponds with that of the mains.

If it does not, carry out the connections on the basis of the available electrical line, as follows:

- for V 380 / 3 phases voltage +Neutral:

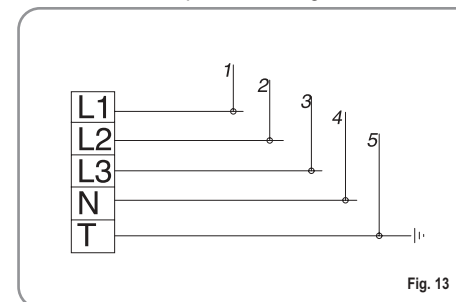

- for V 230 / monophase voltage

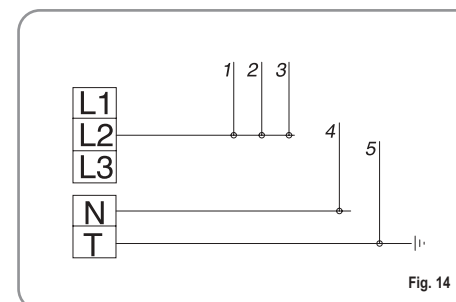

KEY

- 1 Black
- 2 Grey
- 3 Brown
- 4 Blue
- 5 Yellow-green

5. ADJUSTMENTS TO BE MADE BY A QUALIFIED TECHNICIAN ONLY

5.1 FILLING BOILER MANUALLY

NOTE: this operation must be carried out with the machine turned off.

All models *Assolite* are equipped with a level gauge to keep the water level inside the boiler constant.

When using the machine for the first time, it is advisable to fill the boiler by hand to avoid damaging the electrical resistor and turning on the electronic protection.

If this should happen, just turn the machine off and then start it up again to complete its loading procedure (see chapter "MACHINE FUNCTIONS MESSAGE – LEVEL ERROR").

To fill the boiler manually for the first time, proceed as follows:

- remove the worktop grid;
- turn the manual "A" level tap so that water will enter the boiler;
- once the maximum level has been reached, as indicated by the optical level, turn tap "A" off;

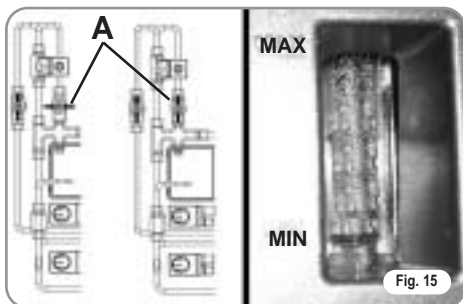

- switch the machine on by placing the general switch on "I"; this will activate the level gauge which will automatically maintain the water level inside the boiler.

5.2 PRESSOSTAT/PUMP ADJUSTMENT

NOTE: this operation can be carried out while the machine is turned on.

To adjust the service pressure of the boiler, thus regulating the water temperature, according to the various functions and needs of the coffee desired, proceed as follows:

- remove the worktop grid cover;
- remove the protective metal sheet by unscrewing the four side screws (A) as shown in the following illustration;
- turn the pump registration screw, turning it



clockwise to INCREASE and counter clockwise to DECREASE the pressure.



Advisable pressure: 1 - 1,4 bar (according to the kind of coffee).

- turn the pump registration screw, turning it clockwise to INCREASE and counter clockwise to DECREASE the pressure.

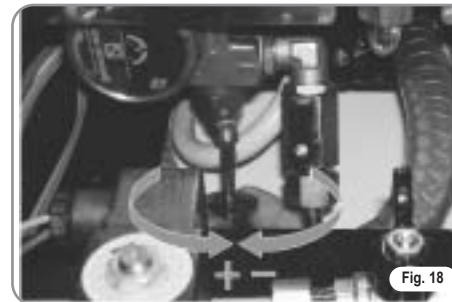

Advisable pressure: 9 bar

- The set pump pressure is shown on the lower part of the gauge.

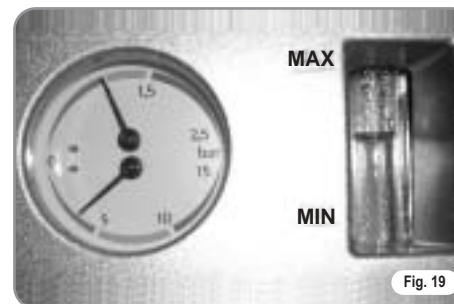

Once the adjustment operation has been completed, screw the protective metal sheet back into its setting and replace the worktop grid cover.

5.3 HOT WATER ECONOMISER ADJUSTMENT

NOTE: this operation can be carried out while the machine is turned on.

All models *Simonelli* are equipped with a hot water mixer tap which adjusts the water temperature and optimises the system's performance. To adjust the hot water economiser, turn the registration knob as follows:

- unscrew the panel (A) situated below the steam and hot water levers;
- remove the panel;
- turn the registration knob

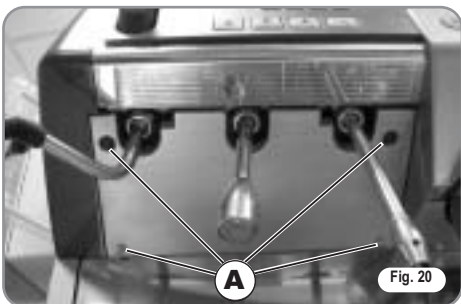

CLOCKWISE/COUNTER CLOCKWISE to INCREASE/DECREASE the hot water temperature;

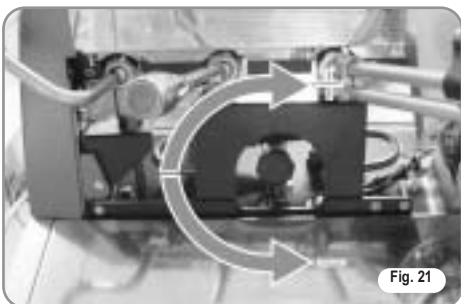

- when the operation has been completed, screw the protective panel back on.

5.4 5.4 CLOCK BATTERY REPLACEMENT (only for the Vip Plus version)

The Vip Plus electronic control unit is equipped with a lithium battery to provide the clock with an approximately three-year autonomy period, after which replacing the battery may prove necessary.

In case the machine has remained unutilised for a long time, the clock can be blocked by proceeding as follows:

- with the machine off the display will read:

OFF

- press the **ENTER** key for 5 seconds; the display will read:

STOP CLOCK

The clock will start up again as soon as the machine is plugged in once more.



WARNING

Replacement of the lithium battery must be carried out **EXCLUSIVELY** by Qualified Technician.

Nuova Simonelli cannot be held liable for any damage to people or things due to non observance of the safety prescriptions described in this booklet.

5.5 PUSH-BUTTON PANEL REPLACEMENT

For correct functioning of the machine, personalising each button panel card at time of replacement is necessary; proceed as follows on the selectors placed on the card (on the key side).

GRUPPO	sw1	sw1	sw1	sw1	sw1	sw1	sw1	sw1
Gruppo 1	On	Off	Off	Off	On	Off	Off	Off
Gruppo 2	Off	On	Off	Off	Off	On	Off	Off
Gruppo 3	Off	Off	On	Off	Off	Off	On	Off
Gruppo 4	Off	Off	Off	On	Off	Off	Off	On

5.6 ELECTRONIC DISPLAYS

Each model can come with the optional electronic displays which can be set by using the dating key. To set, follow the instructions provided in this booklet.

ENGLISH

6. USE

Before starting to use the appliance, the operator must be sure to have read and understood the safety prescriptions contained in this booklet.

The Aurelia Vip Plus model is provided with an optional key management system of waiter keys and technician U key, so that different keys correspond to different functions. The waiter keys can access the normal working functions and can be displayed but not modified on the program menu (Ch.7). The technician U key allows you to access all the functions and to modify the parameters of the programming menu.

ENGLISH



6.1 TURNING THE MACHINE ON

6.1.1 AURELIA VIP PLUS

- Plug the machine in and position the main switch on "I".
- The state of the machine will be shown by the signal: 

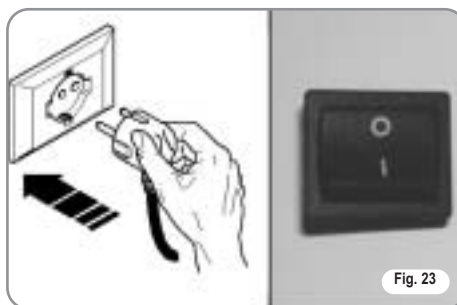

- The unlit display will read:

OFF

NOTE: The machine is not operative in that the main switch only supplies the electronic card.





WARNING

For electronic card maintenance, turn the machine off by means of the external main switch or disconnect the plug.

MANUAL SWITCHING ON/OFF

Automatic On/Off NOT PROGRAMMED

NOTE: make sure that the general switch is always on the position "I".
 The state of the machine will be shown by the signal: 

SWITCH ON: press the  key for 2 seconds, the buzzer will beep, the display will light up to indicate the release of the EPROM for about 1 second. The control unit will start up an auto diagnosis cycle to check the functions, all the selection keys will light up. Once the check is completed the display will read:

HEATING

with the day and time. When 110°C has been reached, the heating message will disappear and will be replaced by the words:

MACHINE READY

NOTE: on completion of the check up all the selection keys are activated.



WARNING

In case the auto diagnosis indicates error or malfunction, call an assistance centre; the operator **MUST NOT** intervene.

SPEGNIMENTO: press the  key for 2 seconds; the machine will turn off and the display will read:

OFF

Automatic On/Off PROGRAMMED

NOTE: make sure that the general switch is always on the position "I".

The state of the machine will be shown by the signal:



SWITCH ON: press the  key for 2 seconds, the buzzer will beep, the display will light up to indicate the release of the EPROM for about 1 second. The control unit will carry out an auto diagnosis cycle to check the functions, all the selection keys will light up. Once the check is completed the display will rea:

HEATING

with the day and time. When 110°C has been reached, the word 'heating' will disappear and will be replaced by:

MACHINE READY

The machine will **SWITCH ON** at the first time set for starting up the coffee maker (see chapter on **PROGRAMMING** and paragraph on **PROGRAMMING ON – OFF**).

NOTA: once the auto diagnosis has been completed all the keys are activated.



WARNING

In case the auto diagnosis indicates error or malfunction, call the assistance centre; the operator **MUST NOT** intervene.

SPEGNIMENTO: press the  key for 2 seconds; the machine will turn off and the display will read OFF

The machine will **SWITCH OFF** at the first time set for stopping the coffee maker (see chapter on **PROGRAMMING** and paragraph on **PROGRAMMING ON – OFF**).

NOTE: the machine can be switched on or off manually as indicated in the previous paragraph.

6.1.2 AURELIA /ESSE

SWITCHING ON: plug the machine in and position the main switch on "I". The state of the machine will be shown by the signal:



Fig. 24



WARNING

In case the auto diagnosis indicates error or malfunction, call the assistance centre; the operator **MUST NOT** intervene.

SWITCHING OFF: press the main switch into the "O" position to switch the machine and the signal off.

6.1.3 AURELIA VIP-VESSE WITH ELECTRONIC DISPLAYS (OPTIONAL)

SWITCHING ON: Plug the machine in and position the "A" switch on "I"; the machine will turn on. By pressing the "B" switch onto position "I" an illuminated display will turn on even when the machine is switched off.

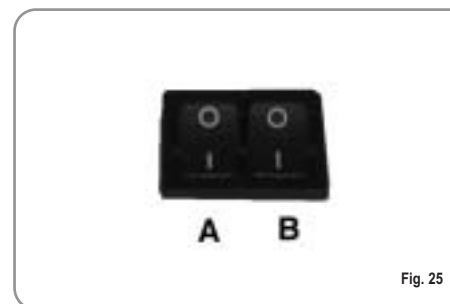

Fig. 25



WARNING

In case the auto diagnosis indicates error or malfunction, call the assistance centre; the operator **MUST NOT** intervene.

ENGLISH

6.2 SELECTION CONFIGURATION

Set the desired function on the available keys placed above the filter-holders (see chapter "DESCRIPTION").

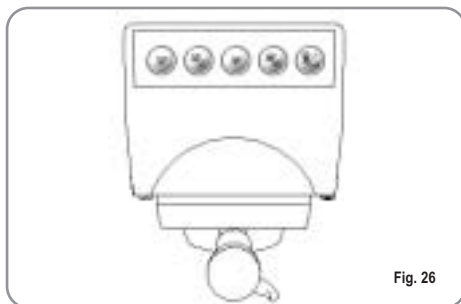

ENGLISH

BUTTONS KEY (Selection configuration)



1 small coffee



2 small coffees



1 long coffee



2 long coffees



Continuous

6.3 MAKING COFFEE

Unhitch the filter-holder and fill it with one or two doses of ground coffee depending on the filter used.



Press the coffee with the provided coffee presser, dust off any coffee residue from the rim of the filter (this way the rubber gasket will last longer).

Insert the filter in its unit
Press the desired coffee button:



1 small coffee



2 small coffees



1 long coffee



2 small coffees

By starting up the coffee brewing procedure the unit's pump is activated and the unit's solenoid valve is opened.

By pressing it, the button will turn on and signal the operation

NOTE: when in pause, leave the filter-holder inserted in the unit so that it will keep warm. To guarantee the utmost thermic stability during use, the delivery units are thermo-compensated with complete hot water circulation.

6.4 USING STEAM

CAUTION
RISK OF BURNS OR SCALDING

While using the steam nozzle, you must pay attention to not place your hands beneath it or touch just after it has been used.

To use steam just pull or push the provided lever (Fig. 28).

By pulling it completely the lever will hold a position of maximum delivery; by pushing it, the lever will automatically give way.

The two steam nozzles are articulated to guarantee their easy use.



6.5 MAKING CAPPUCCINO

To obtain the typical cappuccino foam, immerse the nozzle all the way into a container 1/3 full of milk (preferably cone-shaped). Turn on the steam. Before the milk starts to boil, pull the nozzle slightly up and lightly move it vertically across the surface of the milk. When you have completed the procedure, clean the nozzle carefully with a soft cloth.



Fig. 29

6.6 HOT WATER SELECTION

CAUTION
RISK OF BURNS OR SCALDING

While using the hot water nozzle, pay careful attention not to place your hands beneath it or touch it just after it has been used.

This nozzle delivers hot water to make tea or herb teas.

Place a suitable container under the hot water nozzle (see Fig. 1, position 21)

Press the hot water selection button once  .

Make sure the button lights up.

Water will be delivered from the hot water nozzle for as long as the set time indicates.

NOTE: Hot water can be delivered at the same time as coffee.

6.7 TIMED STEAM NOZZLE

CAUTION
RISK OF BURNS OR SCALDING

While steam is being delivered do not touch the nozzle with any part of the body, and have it always facing downwards towards the cup-holder grid.

It provides steam ejection to foam milk or to heat up other liquids.

Place a suitable container (see Fig. 1 position 16) under the automatic steam nozzle.

Press the steam selection button once  .

Make sure that the button lights up.

Steam will be ejected from the automatic steam nozzle.

Press it again to arrest delivery.

The Plus and V models provide an optional nozzle with a temperature probe which remains on until the beverage being heated reaches the set temperature.

ENGLISH

7. PROGRAMMING

7.1 KEY

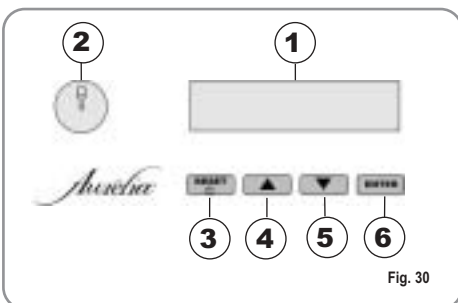

Fig. 30

ENGLISH

- 1 LCD Display.
- 2 Technician/waiter key lock.
- 3 RESET key to turn the machine on and off and to exit menu.
- 4 CURSOR key: to scroll the menu and to increase and decrease values.
- 5
- 6 ENTER key: to access the menu.

LIST OF PROGRAMMABLE FUNCTIONS

- AUTO.CLEAN.CYCLE
- DOSE PROGRAM.
- DELIVERY COUNT
- ON-OFF PROGRAM.
- CUP-WARMER PRO.
- DATE/TIME
- GRINDING
- HISTORICAL ALARM
- MAINTENANCE
- LANGUAGE
- LIGHT ADJUST



Operation to be carried out EXCLUSIVELY by a Qualified Technician. Adjustment by NON qualified technicians can invalidate the guarantee.

7.2 PROGRAMMING AURELIA VIP PLUS

To access the programming units, proceed as follows:

NOTE: the procedure can be carried out with the machine on.

- Insert the key marked U (see chapter "USE") in the provided keyhole.

AUTOMATIC CLEANING CYCLE

(function also available with T visualization key)

- Press the key to access program; the display will read:

AUTO.CLEAN.CYCLE

- Press and the display will read:



AUTO.CLEAN.CYCLE
SELECT

- The central key in each unit will begin to flash on and off. Insert the blind filter (fig 2 A07) into the filter-holder, add half a dose of PULICAFF and attach the filter-holder into the unit where you intend to carry out the automatic cleaning cycle. Carrying out a cleaning cycle in more than one unit at a time is possible.
- Press the key to start the unit automatic cleaning cycle. The display will read:

AUTO.CLEAN.CYCLE
1L

where 1L indicates that the cleaning cycle has been activated within the 1st unit. Once the cycle of 15 deliveries of 5 seconds each, with a 10-second pause between each delivery, has been completed the selected unit key will begin to flash on and off again and the display will read.

RINSE

- Eliminate any residues of PULICAFF from the blind filter and press  the rinsing cycle starting up key of the unit or units where the cleaning cycle has been effected. The letter R will remain on the display like the key . Once the rinsing cycle of the selected unit or units has been completed, the display will read

MACHINE READY

PROGRAMMING DOSES

- Press the  key to access the programming; the display will read:

PROGRAM. DOSES

- Press  and the display will read:

PROGRAM. DOSES
SELECT

All the programmable keys will start to flash on and off.

- Press the coffee key you wish to program; the display will read:

VOLUME C.C.



Followed by the dose amount already set by the manufacturers.

- Vary the dose, by pressing the buttons



- By pressing the coffee key you want to program, delivery will be started up (in the meantime all the other keys will turn off).

- Select the dose of delivered coffee and then press the coffee key you want to program again.

- The display will show the new dose amount which can still be changed by means of the keys   .

- Going on to another selection or pressing the  key. The set coffee key will turn off.

HOT WATER

- Press the  button and make sure that it lights up.

The display will read:



SECONDS



followed by the value already set by the manufacturers.

Press the   keys to vary the hot water delivery time.

- If a new sampling is desired press the  button again.

Delivery starts. When the desired dose has been reached press the button again  .

- The display will show the new dose value set which can still be changed by pressing the   keys.

- Press the  key or go on to a further selection to terminate the operation. The  button will turn off.

TIMED STEAM



- Press the  button and make sure it lights up.

In those models provided with a temperature probe (optional) the control unit automatically recognizes the presence of the

probe and the display will read:

STEAM. TEMP. °C

followed by the temperature set previously by the manufacturer.

Press the   keys to vary the temperature of the beverage you want to heat. When the desired temperature has been reached, the steam delivery will automatically stop.

- In the standard version (without temperature probe), on pressing the  the display will read:



STEAM SECONDS

followed by the amount already set by the manufacturers.

Press the   keys to vary the steam delivery time.

- If a new sampling is desired press the  button again.

Delivery starts. When the desired dose has been reached press the button again  .

- The display will show the new value set which can still be changed by pressing the   .

- Press the  key or go on to a further selection to terminate the operation.

The  button will turn off.

TRANSFERRING DOSES

- When the display reads:

PROGRAM DOSES
SELECT

transferring the set dose to other units is possible by pressing the key.

The display will read:

DOSES TRANSFER
SELECT GROUPS

at this point all the delivery buttons belonging to each individual unit will flash as illustrated in Fig. 31.

- By selecting the continue key once on the first unit (the key will stop flashing but remain lit up), the set values will be transferred from the first unit to the other units

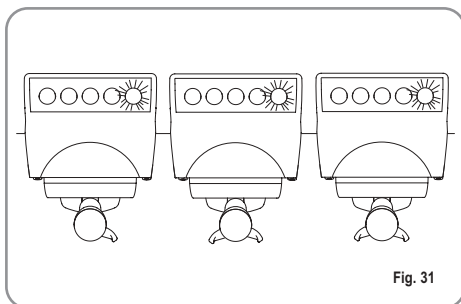

- Press the key to confirm. At this point the display will read:

PROGRAM DOSES
SELECT

- Press the or the key to exit without confirmation.

ENGLISH

TANDARD DOSES

- When the display reads:

DOSES TRANSFER
SELECT GROUPS

we mean to recall the standard dose values.

- Press the key. The display will read:

DEFAULT SETING
SELECT GROUPS

Once again the delivery buttons will begin to flash (see. Fig.31) on and off.

- Select one or more continue keys (the key or keys selected will remain lit up). The key or keys will recall the selected unit's standard doses.
- Press the key to confirm. The display will read:

PROGRAM DOSES
SELECT

NOTE: all the selections can be programmed for a maximum of two minutes; after that time a flashing message will appear on the display saying:

ERROR

DELIVERY COUNT

- The display will read:

DELIVERY COUNT

- By pressing the key the display will read:

SELECTION TOTAL

- All the delivery keys will start to flash on and off. By pressing one of the delivery keys the amount of the deliveries made will be visualised.
 - To set the counter back to zero, press the key.
- NOTE:** The continuous coffee equals one delivery.

- Press to access waiter counts (if provided).
- Press the key and the display will read:

GROUP TOTAL

All the units' small coffee keys will begin to flash on and off.

Example:

By selecting one of the first unit's keys (the selected key will remain lit up) the display will read:

GROUP TOTAL
GR. 1 DELI.

which means the total amount of deliveries for that unit.

- To set the counter back to zero press .
 - To access the waiter counter press .
- When the display reads:

GROUP TOTAL

press and the display will read:

MACHINE TOTAL

This indicates the total amount of deliveries made.

- To set the counter back to zero press **RESET**.
- To access total counts per waiter press **ENTER**.
- By pressing the key the display will read:

CLEANING COUNTER

To access the automatic cleaning counter press **ENTER**.

- The keys will flash on and off; by pressing the unit key the number of cleaning cycles effected will appear. By pressing the key (reset) for 5 seconds the counter will be set back to zero.

ON/OFF PROGRAM.

- The display reads:

ON-OFF PROGRAM

- By pressing the **ENTER** the display will read:

MONDAY
ON 07:30 OFF 23:30

where the ON and OFF values indicate when the machine will turn on and off.

- Press to change the day forward and backward.
- Press **ENTER** to vary the programmed starting up time (the message ON 07:30 will start to flash on and off).

- Use the keys to vary the starting up time.

- Press **ENTER** to confirm and to go on to the programmed switching off time (the message OFF 23:30 will start to flash on and off).

- Use the keys to vary the switching off time.

- Confirm by pressing **ENTER**.

- To de-activate the on/off function on weekly day-off, press **RESET**.

The display will read:

DAY OFF

(to reinstate, press **RESET**)

After the word SUNDAY, by pressing again, a beep will signal that you have come to the following page.

CUP-WARMER PROGRAMMING

- The display will read:

CUPWARMER PROG.

- By pressing the **ENTER** the display will read (for example):

ON05 OFF60

The words ON05 will begin to flash on and off; use the keys to vary the opened cup-warming time (anywhere between 0 and 60 minutes).

- Press **ENTER** to confirm and to set the cup-warmer at OFF, which includes from 0 to 60 minutes.

NOTE: By programming one of the two ON/OFF values at 0, will automatically exclude the function.

When the cup-warmer has been set, the button will start to slowly flash.

- Press the **ENTER** key to go on to the next page

DATE/TIME PROGRAMMING

- The display will read:

DATE/HOUR

- By pressing the **ENTER** key, the display will read for example:

MONDAY 08:22
08-MAR-03

The times will start to flash on and off.

- Vary the hours and the minutes by using the keys .

- Confirm by pressing the **ENTER** key.

Once the hours and the minutes have been varied press **ENTER** again and vary the day, the month and the year by using the same procedure as described above.

On completion press **ENTER** to go on to the next page.

GRINDING CONTROL PROGRAMMING

The Program Vip Plus model is provided with an electronic system able to detect delivery parameter variations dependent on how coarse or fine the coffee powder is.

- The display will read:

GRINDING

- By pressing the **ENTER** key the display will read:

1ESPRESSO 00-40
2ESPRESSO 00-40

where 00-40 indicates the maximum time (in seconds) allotted for the delivery of a sample amount of coffee, equal to 10cc for a single coffee and 30cc for a double coffee. The first value will begin to flash on and off, modify by using the keys.

To confirm press the **ENTER** key.

- Press the **ENTER** key again to go on to the next value.
To modify the previous value, proceed as described above.

NOTE: If the system detects a delivery time (of the sampled amount) inferior to the programmed minimum, the display will read:

COARSE GRINDING

(See chapter called "MACHINE FUNCTION MESSAGES") which means you have to adjust the coffee grinder to reduce the grain.

If the system detects a delivery time

(of the sampled amount) superior to the programmed maximum, the display will read:

FINE GRINDING

(See chapter called "MACHINE FUNCTION MESSAGES") which means you have to adjust the coffee grinder to increase the grain. By setting the values at 00-40, the function is excluded.

- On completion press **ENTER** to go on to the next page

HISTORICAL ALARM VISUALISATION

- The display will read:

FAULTS HISTORY

- By pressing the **ENTER** key, the display will read:

ERROR 01

- Pressing the key, allows you to scroll down the ten previous alarms saved in the memory. After the tenth alarm, by pressing the key again you can go on to the next page.

MAINTENANCE PROGRAMMING

- The display will read:

MAINTENANCE

- By pressing the **ENTER** key, the display will read:

DELIVE. 10000
01 GENNUARY 2005

- Use the keys to set both values.

- Use the **ENTER** key to confirm.

Once the set delivery limit or the set maintenance date have been reached, the display will visualize the message:

MAINTENANCE

Insert the "U" key (see chapter "USE") and set the display back to zero by pressing the key.

To go on to the next page, press the key.

SELECTING THE DESIRED LANGUAGE

- The display will read:

LANGUAGE

- Press the **ENTER** key to visualise the language already set. Choose the desired language by using the keys.
- To confirm press **ENTER**.

KEYBOARD LIGHTING ADJUSTMENT

- The display reads:

LIGHT ADJUSTMENT

- By pressing the **ENTER** key, the display will read:

LIGHT ADJUSTMENT
3

- Select the value of desired brightness choosing from a minimum value of 1 to a maximum of 6 by using the keys.
- Confirm by pressing .

The display will visualize the message:

MACHINE READY

7.3 PROGRAMMING AURELIA V

DOSE PROGRAMMING

To access the programming units, proceed as follows:

NOTE: the procedure can be carried out with the machine on.

- To access the dose programming state of each unit press the first unit's continuous delivery key for 5 seconds.
- The delivery keys will begin to flash on and off.
- Access into the first unit's programming allows you to set the machine's function parameters.

COFFEE DOSE PROGRAMMING

To program the relative water doses for one of the delivery keys, proceed as follows:

- fill the filter-holder with the correct dose of coffee (the filter-holder can be single or double depending on the key you wish to program).
- Insert the filter-holder into the unit.

- Press one of the delivery buttons (see illustration):



- The delivery will start; once the desired amount has been reached, press the continuous key.
- The delivery will stop and the chosen dose key will turn off (the other keys will continue to flash).
- Press the continuous key to exit programming or to continue programming other dose keys.

NOTE: This procedure is usable on all the machine units except if carried out one at a time; the other groups can carry on normally.

HOT WATER PROGRAMMING

- Access the programming according to the relative procedure.
- Press the hot water selection key .
- Hot water delivery will start.
- Establish the desired hot water dose and press the key again .
- Press the continuous key to exit the programming or to continue programming other selection keys.

TIMED STEAM PROGRAMMING

- Access the programming according to the relative procedure.

- Press the steam selection key .
- Steam ejection will start.
- Establish the desired dose of steam and press the key again .
- Press the continuous key to exit the programming or to continue programming other selection keys.

AUTOMATIC CUP-WARMER PROGRAMMING

- Access the programming according to the relative procedure.
 - Press the cup-warming selection key .
 - The delivery keys of the first and second unit will respectively signal the allotted automatic switching on and off times while the continuous keys of the first and second units will flash on and off.
- As described in the chart, each delivery key has an associated value, the starting up time of the cup-warmer is given by adding up the values of the first unit's lit-up keys. The same counting method is used for the cup-warmer switching off time with the keys of the second unit.

Key	1° GROUP (time ON)	2° GROUP (time OFF)
	2 minutes	5 minutes
	4 minutes	10 minutes
	8 minutes	20 minutes
	16 minutes	40 minutes

LEVELLING PUMP ACTIVATION

- Access the programming according to the relative procedure.
- Press the second unit continuous key (the key will light up).
- Press the second unit 1 small coffee key.

NOTE: If the 1 small coffee key is lit up, the pump will start up during the level. If the 1 small coffee key is not lit up, the pump will not start up during the level.

- Press the second unit continuous key.

In this way the selected pump setting is stored.

- To exit the programming, press the first unit continuous key.

NOTE: The settings will be saved even when exiting the first unit programming directly.

ADJUSTING KEYBOARD LIGHTING INTENSITY

- Access the programming according to the relative procedure.
- Press the second unit continuous delivery key.
- The second unit 2 long coffees delivery key will flash on and off.
- Press the key more than once to vary the light intensity.

NOTE: You can set a maximum of five different degrees of light intensity.

- To store the set light intensity values in the memory, press the second unit continuous delivery key.
- To exit the programming, press the first unit continuous delivery key .

NOTE: The settings will be saved even when exiting the first unit programming directly.

STEAM NOZZLE WITH TEMPERATURE PROBE (OPTIONAL)

- Make sure the temperature probe is connected to the control unit.
- Access the dose programming as described.
- Press the selection key.
- Set the temperature by pressing the first and second unit keys.
- The set temperature corresponds to the sum of the value of the selected keys.

Key	1° GROUP	2° GROUP
	2 °C	5 °C
	4 °C	10 °C
	8 °C	20 °C
	16 °C	40 °C

- If none of the unit keys are selected (light on) the temperature probe function will be de-activated and the key will work on ON-OFF mode.

STANDARD DOSE PROGRAMMING

- Setting predetermined values for the four doses of the first delivery unit is not possible. To do so, you must:
- Press the first unit continuous delivery key and keep pressing it for at least 8 seconds, until the flashing delivery keys of the first unit turn off.
- The standard doses are illustrated in the following table:

40 cc	60 cc	50 cc	85 cc	9 sec.	0 sec.

NOTE: A time of 0 seconds for water and steam give way to their continuous functioning

DOSE COPYING



For units 2, 3 and 4 of the machine *Assoluce* it is possible to set the four doses by copying those set for the first unit. This procedure must be carried out for each unit individually once the first unit programming has been accessed:

- press the continuous delivery key of the unit you desire to copy the doses onto and keep pressing it for at least 8 seconds, until the flashing delivery keys turn off.

7.4 PROGRAMMING AURELIA ESSE

DOSE PROGRAMMING

In the Aurelia Esse version only the doses of water and timed steam can be programmed. To access the programming state you must:

- press the cup-warming key  for five seconds.
- The selection keys and the 1 long coffee key  belonging to the first unit will start to flash on and off while the other delivery keys of the other units will turn off.

HOT WATER

- Once the programming state has been accessed, by pressing the  key,

hot water delivery will be activated; once the desired dose has been reached press the  key again and the set delivery time will be stored in the control unit

TIMED STEAM

- Once the programming state has been accessed, by pressing the  key,



hot water delivery will be activated; once the desired dose has been reached press the  key again and the set delivery time will be stored in the control unit



ADJUSTING LIGHTING INTENSITY KEYBOARD

- Access programming according to the relative procedure.
- Adjust the light intensity of the keys by pressing the first unit's 1 long coffee  key more than once.

NOTE: To exit programming press the  key.

ACTIVATING LEVELLING PUMP

- Access programming according to the relative procedure.
- Press and keep pressing the 1 long coffee  key belonging to the second unit.
- To set the activation of the pump during levelling, once the programming state has been activated,  keep the second unit key pressed.

The second unit key  will light up and by means of the first unit  key the pump setting will be visualized: if it is lit up the pump will function during levelling; if it is not lit up the pump will not be activated during levelling.

By pressing the first unit  key the pump setting during levelling can be modified.

NOTE: to exit the programming press the  key.

8. CLEANING AND MAINTENANCE

8.1 SWITCHING OFF THE MACHINE

To switch the machine off press the main switch and set the machine to the O energy position.



Fig. 32

8.2 CLEANING THE OUTSIDE OF THE MACHINE

Before carrying out any cleaning operations, set the machine to the "O" energy level, (machine switched off and plug removed from the mains).

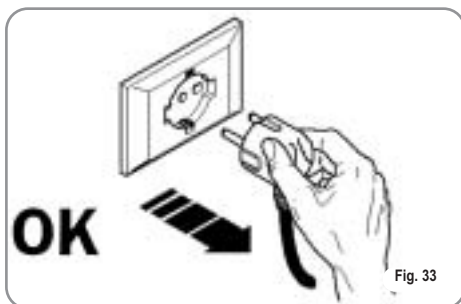

Fig. 33



WARNING

Do not use solvents, chlorine-based products or abrasives.

Cleaning the work area: remove the worktop, lifting it up from the front and sliding it out. Remove the water collection dish underneath and clean everything with hot water and cleansers.

Cleaning the bottom: To clean all the chromium-plated areas, use a soft, damp cloth.

8.3 CLEANING THE STAINLESS COFFEE-HOLDERS

The stainless coffee-holders are situated under the delivery units, as shown in figure (34).



NOTE: To clean proceed as follows:

- Turn the screw placed in the centre of the coffee-holder.
- Slide the coffee-holder out and check that its holes are not obstructed but clean.
- If obstructed, clean as described (Paragraph "CLEANING FILTERS AND FILTER-HOLDERS") We recommend cleaning the coffee-holder once a week.

8.4 CLEANING THE UNIT WITH THE AID OF THE BLIND FILTER

The machine is pre-set for cleaning the delivery unit with a specific washing powder.

The machine will initiate washing cycle which consists in the circulation of hot water followed by regular breaks.

We recommend carrying out a washing cycle at least once a day with special cleansers.



**CAUTION
RISK OF INTOXICATION**

Once the filter-holder has been removed, repeat delivery operations a few times to eliminate any cleanser residues.

To carry out the washing procedure, proceed as follows:

- 1) Substitute the filter with the delivery unit blind filter.
- 2) Fill it with two spoonfuls of special cleanser powder and insert it into the unit filter-holder.
- 3) Press one of the coffee keys and halt it after 10 seconds
- 4) Repeat the procedure several times
- 5) Remove the filter-holder and carry out a few deliveries.

8.5 CLEANING FILTERS AND FILTER-HOLDERS

Place two spoonfuls of special cleanser in half a litre of hot water and immerse filter and filter-holder (without its handle) in it leaving them to soak for at least half an hour. Then rinse abundantly with running water.

8.6 RESIN AND SOFTENER REGENERATION

To avoid scaling deposits in the boiler and in the heating exchangers, the softener must always be kept efficient. Therefore, the ionic resins must be regularly regenerated.

Regeneration times are established according to the quantity of coffee delivered daily and the hardness of the water utilised.

As an indication, regeneration times can be calculated on the basis diagram illustrated in Fig. 35.

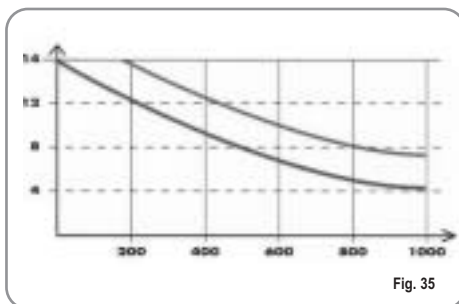

Regeneration procedures are as follows:

- 1) Turn the machine off and place a container large enough to contain at least 5 litres under tube E (Fig. 36).

Turn levers C and D from left to right; take the cap off by unscrewing knob and fill with 1 Kg normal kitchen salt (Fig. 37).

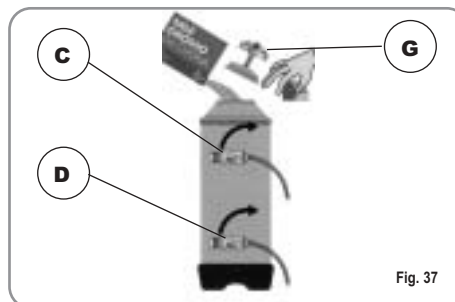
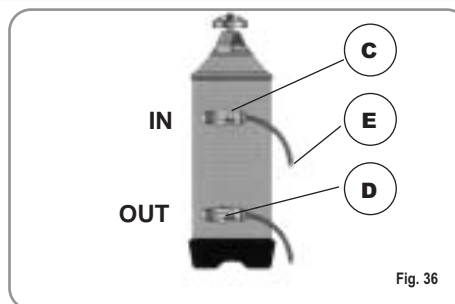

- 2) Put the cap back on and reposition lever C moving it towards the left (Fig. 38) and allowing tube F to discharge the salty water until it has been eliminated and the water becomes fresh again (about half an hour).

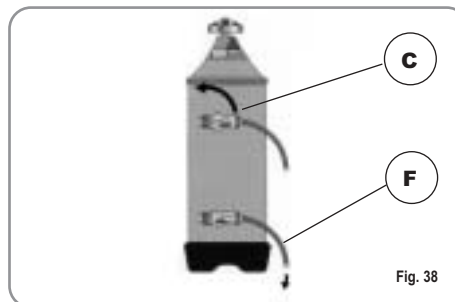



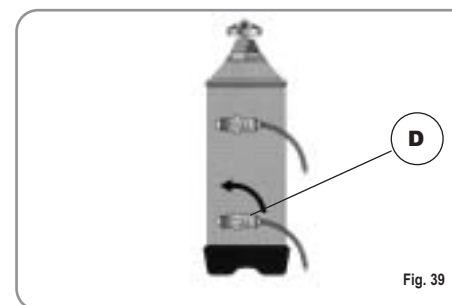







- 3) Reposition lever D towards the left (Fig. 39).









ENGLISH

9. AURELIA PLUS MACHINE FUNCTION MESSAGES

ENGLISH

DISPLAY AND KEY INDICATIONS	CAUSE	EFFECT	SOLUTION	NOTES
DIAGNOSIS OF ERROR	At the time of the diagnosis the system presents faults within the control unit EPROM.	The machine will not heat and all its functions will be blocked.		
DELIVERY ERROR 	On reaching delivery time limit (120 seconds) the doser doesn't send out its set commands.	The display indicator and the 'continuous' key belonging to the relative unit will flash on and off.	Press the  key or one of the keys  	
DOSER ERROR 	If the doser doesn't send out its set commands within the first three seconds from delivery onset.	If the delivery isn't manually halted, the maximum time limit (120 sec) will be blocked.	Press the  key or one of the keys  	
	If after 90 sec of machine functioning the water level is not re-established.	The display indicator will flash on and off. The pump is de-activated. The resistor and all the functions are halted.	Turn the machine off and then turn it on again. All its functions will be re-activated.	
	When the machine's temperature is higher than 130°C.	The display indicator will flash on and off and the resistor is de-activated.	The system will be re-established as soon as the temperature goes below 130°C.	The boiler is provided with a manual refitting safety thermostat; if the resistor is not re-established, call a qualified technician.

DISPLAY AND KEY INDICATIONS	CAUSE	EFFECT	SOLUTION	NOTES
	<p>Incorrect electrical input caused by a malfunction in one of the machine charges.</p>	<p>The display reading will flash. The pump will switch off. The heating element and all other functions will be disabled.</p>	<p>Switch off the machine and send for a specialist technical engineer.</p>	
<p>FINE GRINDING</p>	<p>The machine registers values different from the set values.</p>	<p>A much longer delivery time.</p>	<p>Modify grinding degree and press the key</p>  <p>or one of the keys</p>  	<p>By leaving the machine in the programming state, within 10 minutes from the last selection, the system will return to the previous configuration and the display will indicate its reestablishment of normal functioning.</p>
<p>COARSE GRINDING</p>	<p>The machine registers values different from the set values.</p>	<p>A much shorter delivery time.</p>	<p>Press the</p>  <p>key or one of the keys</p>  	

10. Aurelia V MACHINE FUNCTION MESSAGES

ENGLISH

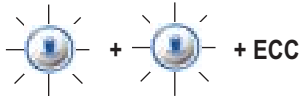
DISPLAY AND KEY INDICATIONS	CAUSE	EFFECT	SOLUTION	NOTES
	If the doser doesn't send out its commands within three sec from the onset of delivery.	If the delivery is not halted manually, the time limit (120 sec.) will be blocked.	Interrupt the delivery.	
	If within 90 sec. from onset, with pump inserted during the levelling, at 180 sec., if the level has not been re-established.	The pump, the resistor and all the functions will be halted.	Turn the machine off for at least 5 sec. and then switch it on again.	

11. Aurelia S MACHINE FUNCTION MESSAGES

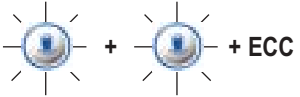
DISPLAY AND KEY INDICATIONS	CAUSE	EFFECT	SOLUTION	NOTES
	<p>If within 90 sec. from onset, with pump inserted during the levelling, at 180 sec., if the level has not been re-established.</p>	<p>The pump, the resistor and all the functions will be halted.</p>	<p>Turn the machine off for at least 5 sec. and then switch it on again.</p>	

ENGLISH

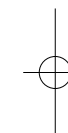
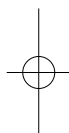

IMPIANTO ELETTRICO /ELECTRIC SYSTEM Aurelia S

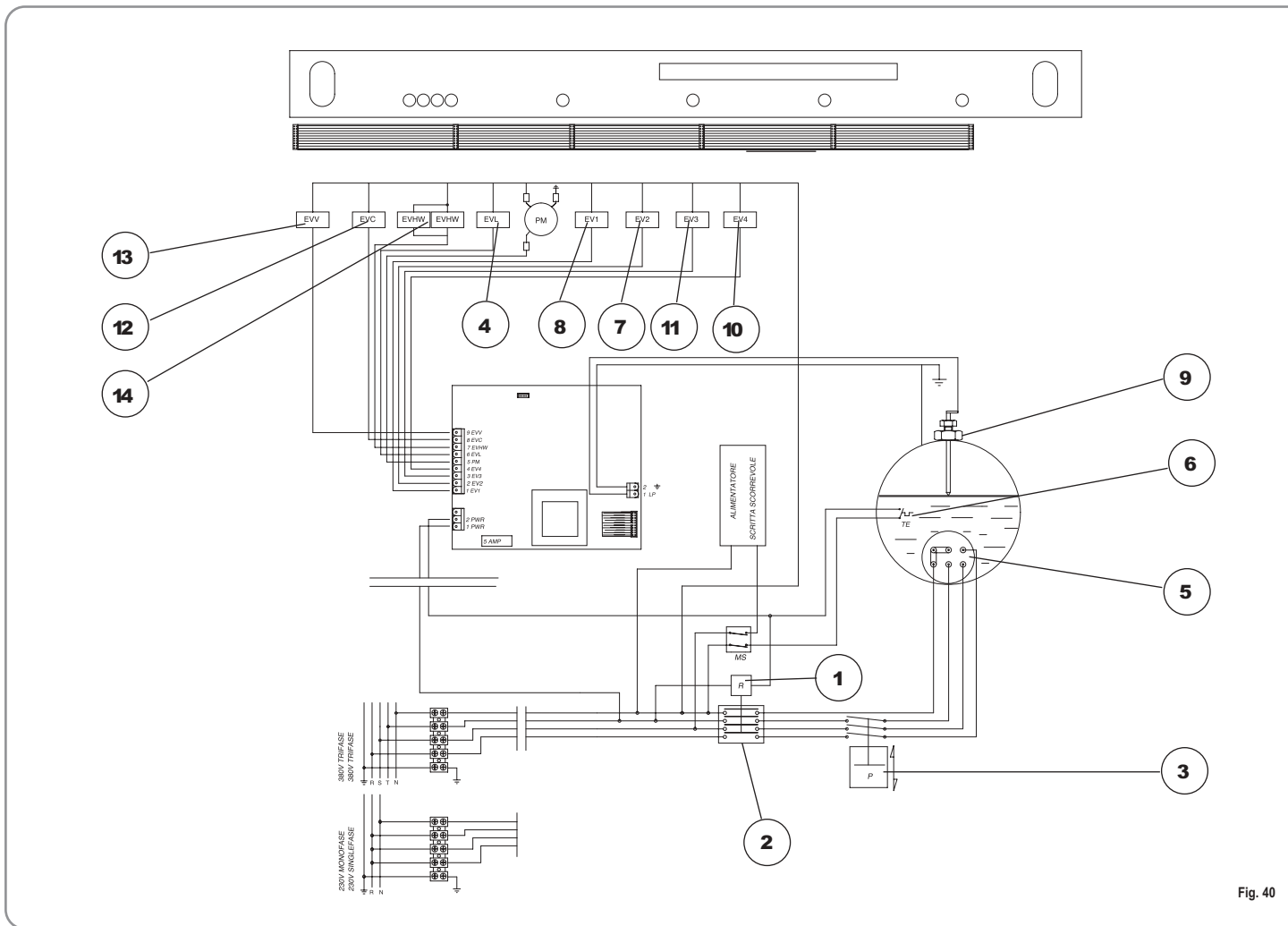

Fig. 40

LEGENDA/KEY

- | | | |
|---|---|--|
| 1 MS Interruttore/ Main Switch. | 8 Valve unit 2. | 9 Valve unit 3. |
| 2 R Relè/Relay. | 9 EV1 Elettrovalvola gruppo 1/Solenoid Valve unit 1. | 12 EVHW Elettrovalvola miscelatore/Solenoid Valve mixer. |
| 3 P Pressostato/Pressostat. | 10 EV4 Elettrovalvola gruppo 4/Solenoid Valve unit 4. | 13 EVC Uscita scaldatazze/Cup-warmer out put. |
| 4 PM Motore pompa/Pump Motor. | 11 EV 3 Elettrovalvola gruppo 3/Solenoid | 14 EVL Elettrovalvola livello/Solenoid Valve level. |
| 5 HE Resistenza boiler/ Heater ELEMENT. | | |
| 6 TE Termostato/Thermostat. | | |
| 7 EV2 Elettrovalvola gruppo 2/ Solenoid | | |

IMPIANTO ELETTRICO /ELECTRIC SYSTEM Aurelia Plus Rel 3.xx

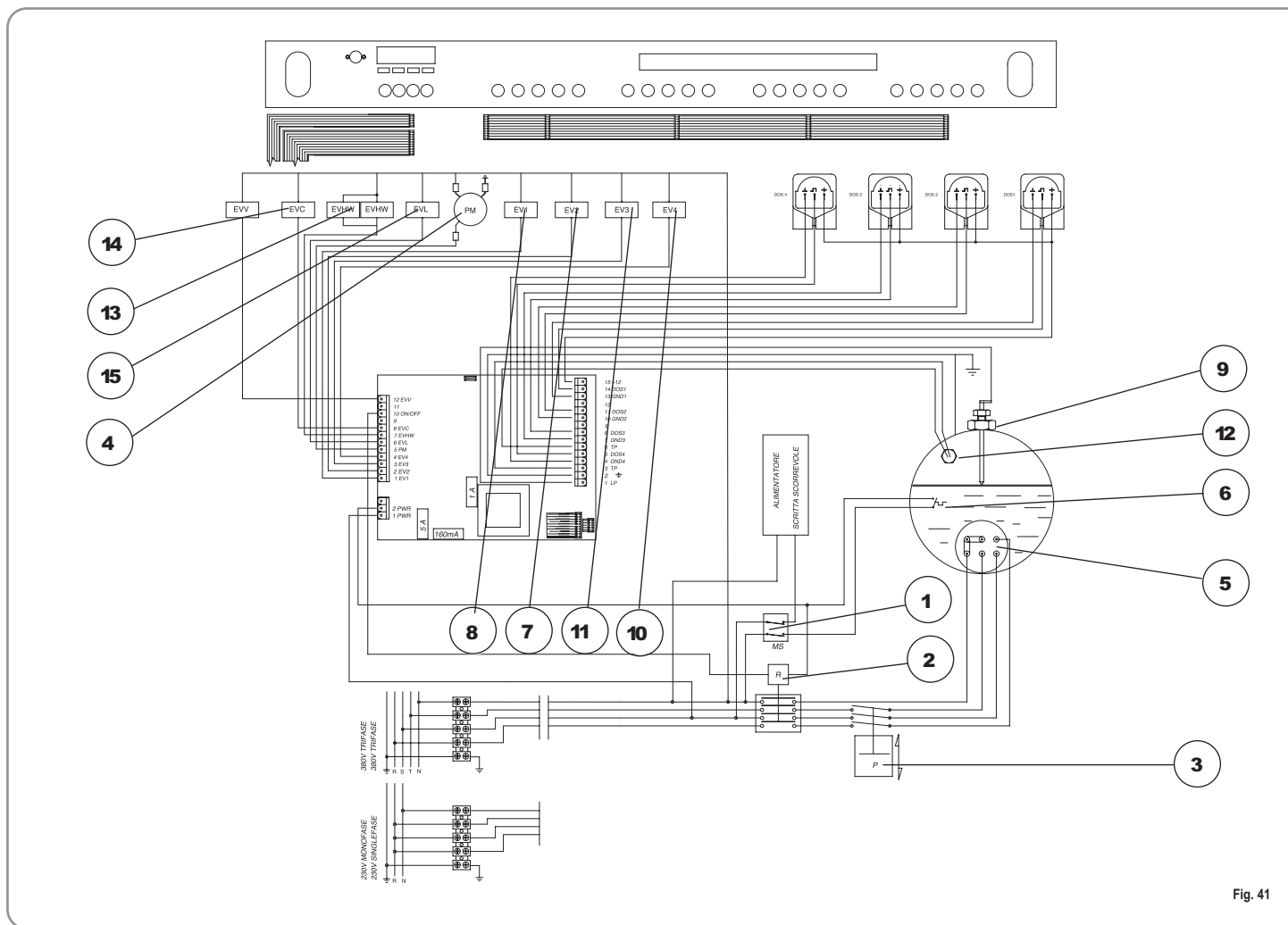

Fig. 41

LEGENDA/KEY

- 1 MS Interruttore/ Main Switch.
- 2 R Relè/Relay.
- 3 P Pressostato/Pressostat.
- 4 PM Motore pompa/Pump Motor.
- 5 HE Resistenza boiler/ Heater ELEMENT.
- 6 TE Termostato/Thermostat.
- 7 EV2 Elettrovalvola gruppo 2/ Solenoid

- 8 EV1 Elettrovalvola gruppo 1/Solenoid Valve unit 1.
- 9 LP Sonda livello/ level Probe.
- 10 EV4 Elettrovalvola gruppo 4/Solenoid Valve unit 4.
- 11 EV 3 Elettrovalvola gruppo 3/Solenoid Valve unit 3.

- 12 TP Sonda temperatura/ Temperature Probe
- 13 EVHW Elettrovalvola miscelatore/Solenoid Valve mixer.
- 14 EVC Uscita scald tazze/Cup-warmer output.
- 15 EVL Elettrovalvola livello/Solenoid Valve level.

IMPIANTO ELETTRICO /ELECTRIC SYSTEM Aurelia Plus Rel 1.xx

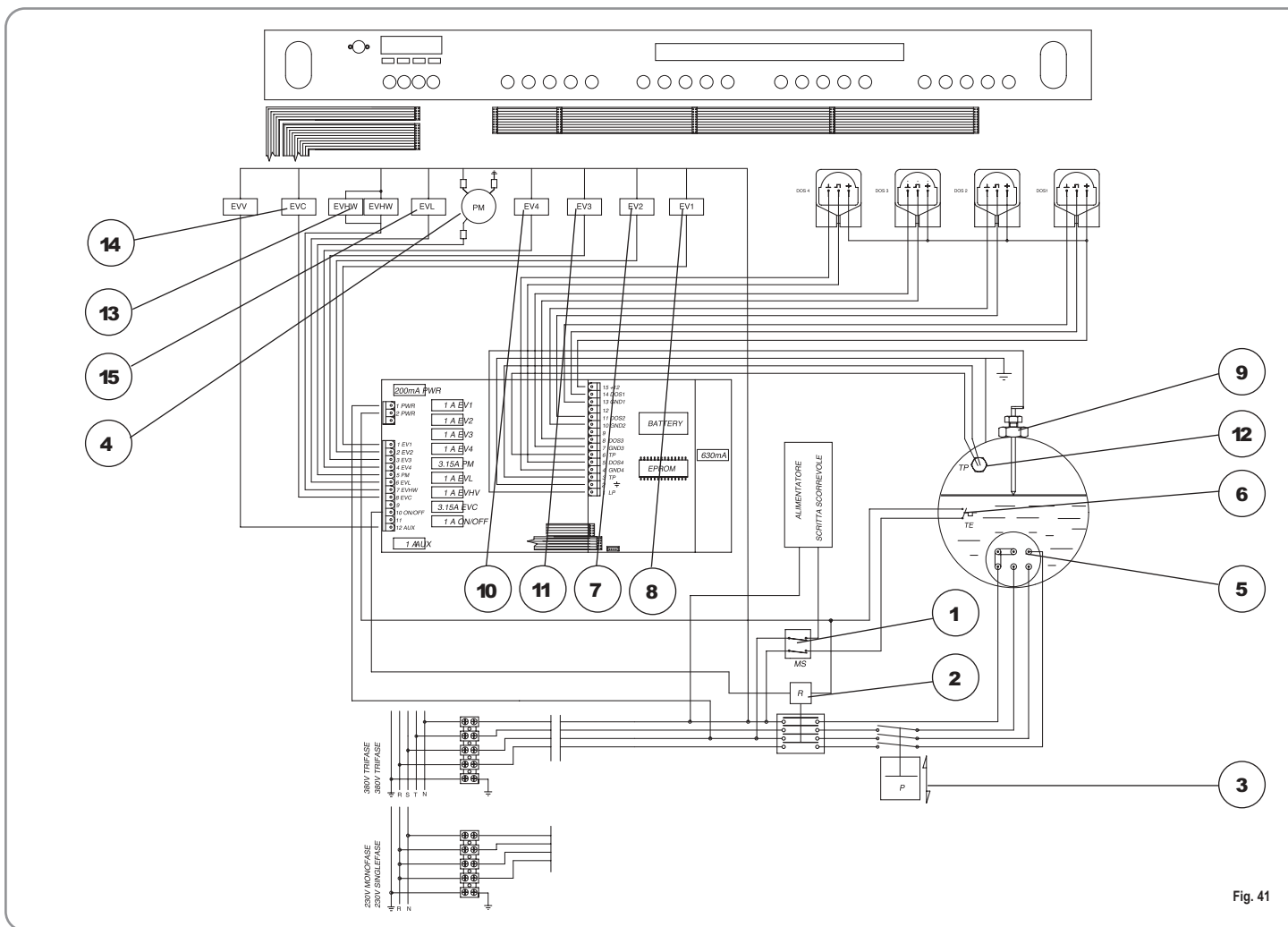

Fig. 41

LEGENDA/KEY

- 1 MS Interruttore/ Main Switch.
- 2 R Relè/Relay.
- 3 P Pressostato/Pressostat.
- 4 PM Motore pompa/Pump Motor.
- 5 HE Resistenza boiler/ Heater ELEMENT.
- 6 TE Termostato/Thermostat.
- 7 EV2 Elettrovalvola gruppo 2/ Solenoid

- 8 EV1 Elettrovalvola gruppo 1/Solenoid Valve unit 1.
- 9 LP Sonda livello/ level Probe.
- 10 EV4 Elettrovalvola gruppo 4/Solenoid Valve unit 4.
- 11 EV 3 Elettrovalvola gruppo 3/Solenoid Valve unit 3.

- 12 TP Sonda temperatura/Temperature Probe
- 13 EVHW Elettrovalvola miscelatore/Solenoid Valve mixer.
- 14 EVC Uscita scald tazze/Cup-warmer out put.
- 15 EVL Elettrovalvola livello/Solenoid Valve level.

IMPIANTO ELETTRICO /ELECTRIC SYSTEM Aurelia V

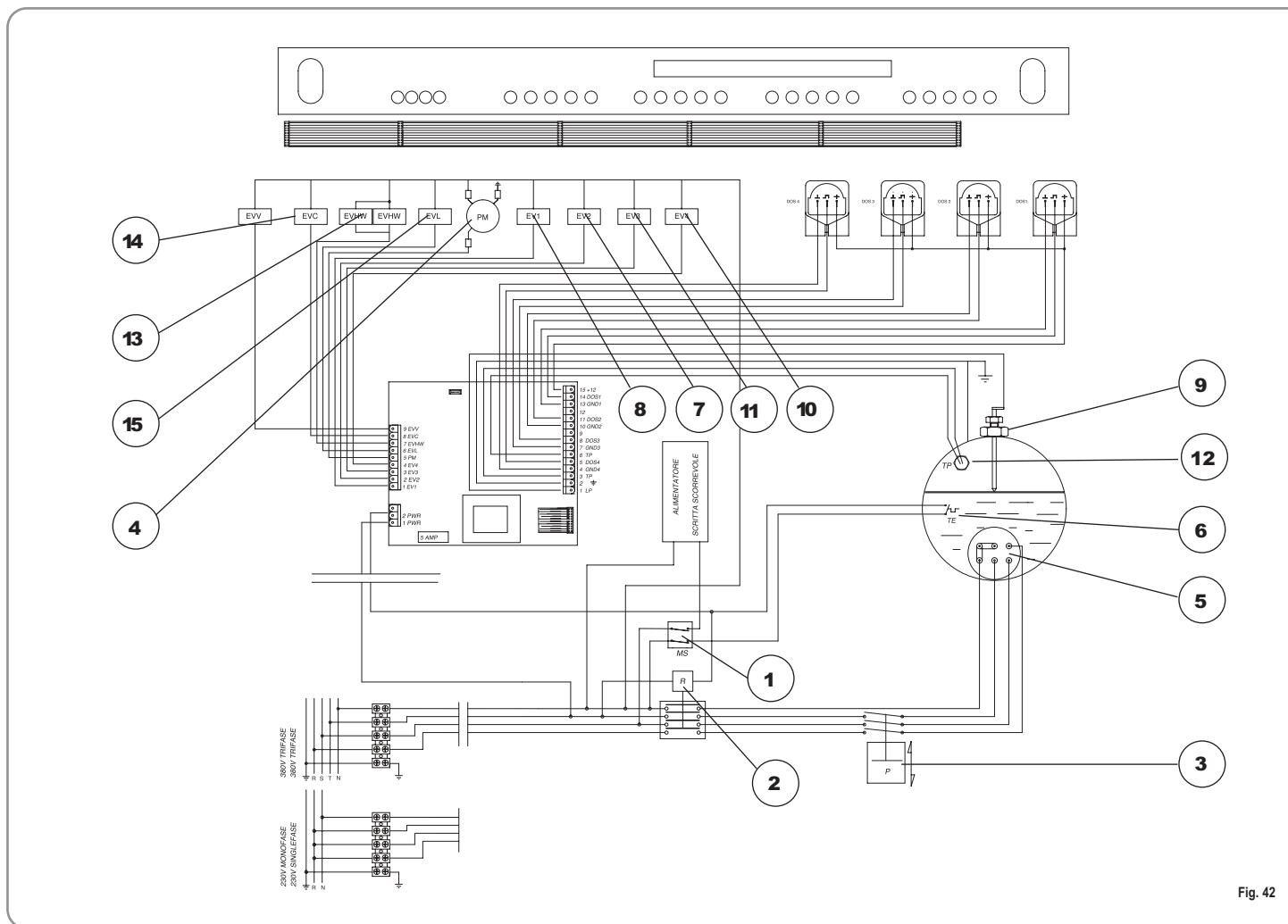

Fig. 42

LEGENDA/KEY

- 1 MS Interruttore/ Main Switch.
- 2 R Relè/Relay.
- 3 P Pressostato/Pressostat.
- 4 PM Motore pompa/Pump Motor.
- 5 HE Resistenza boiler/ Heater ELEMENT.
- 6 TE Termostato/Thermostat.
- 7 EV2 Elettrovalvola gruppo 2/ Solenoid

- 8 EV1 Elettrovalvola gruppo 1/Solenoid Valve unit 1.
- 9 LP Sonda livello/ level Probe.
- 10 EV4 Elettrovalvola gruppo 4/Solenoid Valve unit 4.
- 11 EV 3 Elettrovalvola gruppo 3/Solenoid Valve unit 3.

- 12 TP Sonda temperatura/Temperature Probe
- 13 EVHW Elettrovalvola miscelatore/Solenoid Valve mixer.
- 14 EVC Uscita scald tazze/Cup-warmer output.
- 15 EVL Elettrovalvola livello/Solenoid Valve level.

IMPIANTO IDRAULICO / PLUMBING SYSTEM

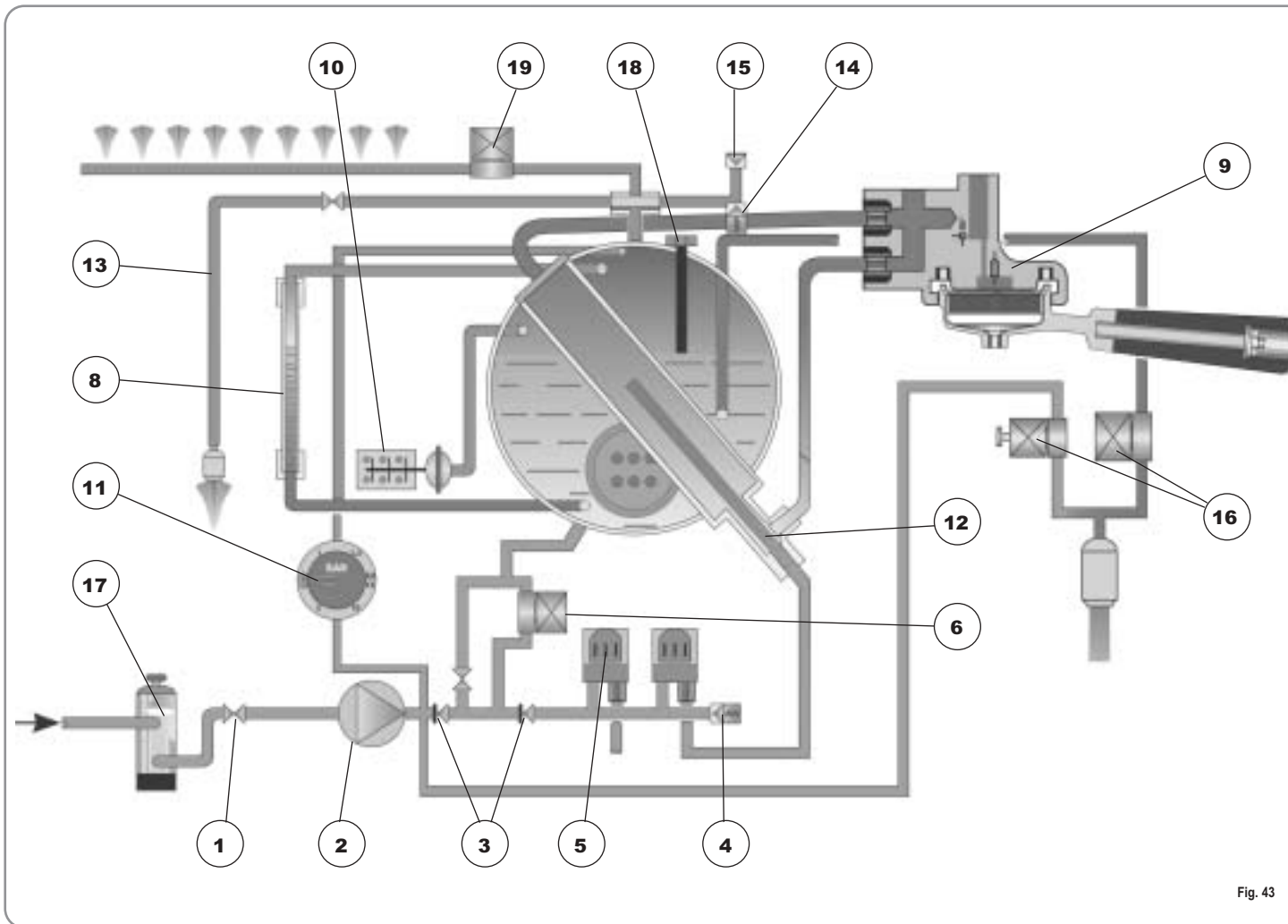

Fig. 43

LEGENDA/KEY

- | | | |
|--|---|---|
| 1 Rubinetto ingresso acqua/Water entrance faucet | 7 Rubinetto livello manuale/Manual level faucet | 14 Valvola di sicurezza cald./Heater safety valve |
| 2 Pompa/Pump | 8 Livello acqua/Water level | 15 Valvola antirisucchio/Anti-suction valve |
| 3 Valvola di ritegno/Check valve | 9 Gruppo erogatore/Delivery unit | 16 Economizzatore acqua calda/Hot water economiser |
| 4 Valvola neplas/Neplas valve | 10 Pressostato/Pressostat | 17 Depuratore/Purifier |
| 5 Dosatore volumetrico/Volume doser | 11 Manometro doppia scala/Double scale gauge | 18 Sonda livello/Level probe |
| 6 Elettrovalvola di livello/Solenoid valve level | 12 Scambiatore di calore/Heat exchanger | 19 Scaldatazze a vapore (optional)/Steam cup-warmer (optional). |
| | 13 Vapore/Steam | |