

Eagle One 2 Group

Installation Requirements



Water

- 3/8" dedicated cold water line with shut-off valve and compression fitting.
- Water hardness 3gpg or 50 ppm.
- Line pressure 2-4bar, cold water.
- Water flow rate Minimum 1 GPM
- Filtration ≤ 1.0 micron
- TDS 50-250 ppm
- Alkalinity 10-150 ppm
- Chlorine ≤ 0.50 ppm
- PH 6.5-8.5

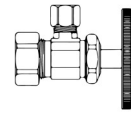

Shut off valve



Nema L6-30
Twist
(receptacle)

Power

- Volts: 220 (range of 208-240)
- Watts: 5000
- Amp draw: 24
- Receptacle: Nema L6-30 Twist

Drain

- Open gravity drain of minimum 1.25 inch I.D., within 4 feet of the machine.

Counter Space

- Height: 23 inches
- Depth: 23 inches
- Width: 30 inches

Countertop Drain Hole Location

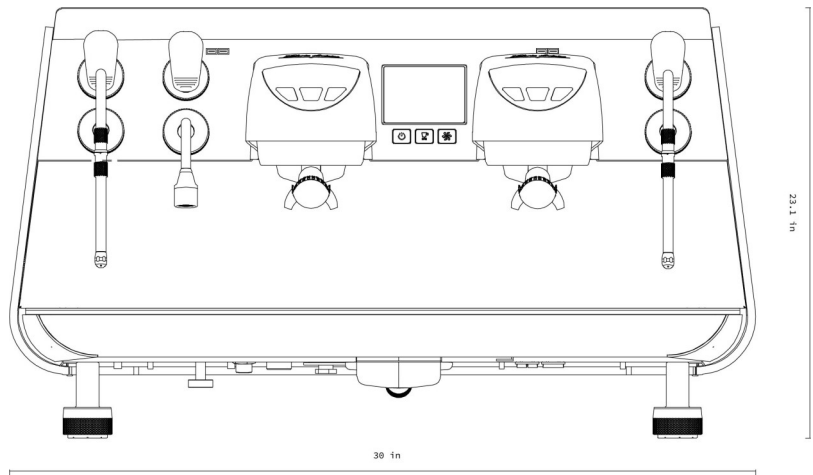
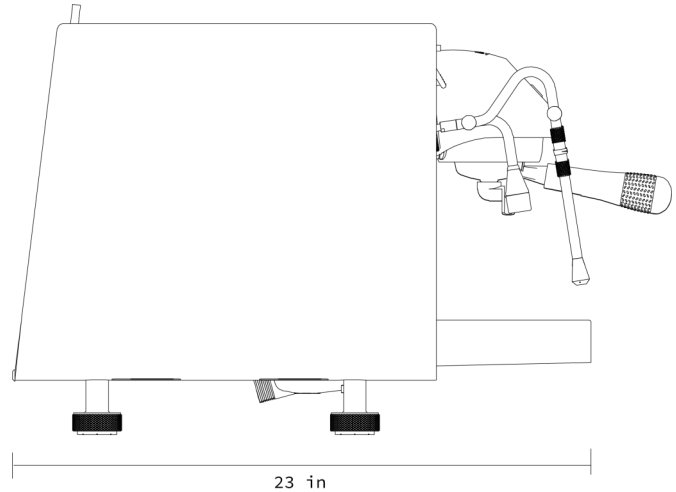
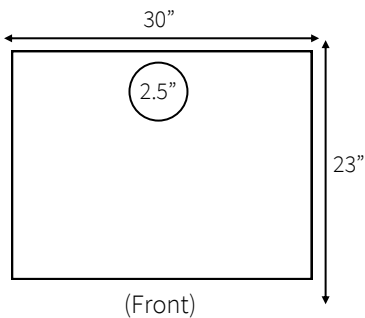

I, the customer, understand that these requirements must be in when the installer arrives. Failure to have the site ready will result in additional service and travel charges, and may cause further delays in installation.

Customer Name: _____ Signature: _____

Company Name: _____

Phone: _____ Email: _____ Reference number: _____